

## COMMERCIAL KICK PLATES

ARMOR PLATE

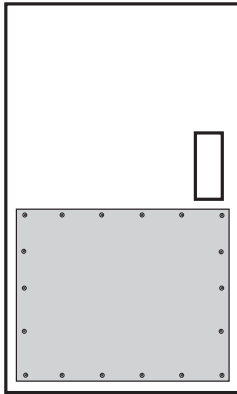

KICK PLATE

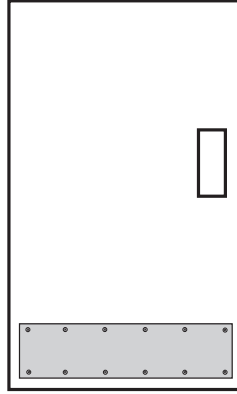

MOP PLATE

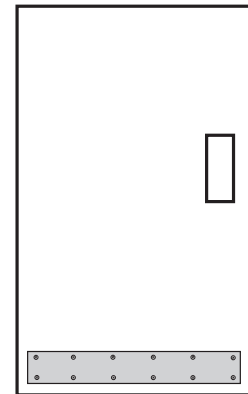

**ANSI:  
J101 Metal / J105 Plastic**

Up to 48"h x 48"w for some finishes

**ANSI:  
J102 Metal / J106 Plastic**

8" to 16"h x 48"w

**ANSI:  
J103 Metal / J107 Plastic**

under 8"h to 48"w

**FASTENERS:**

- Individually packaged with screws #6 x 5/8" SMS
- Full threaded to the head stainless steel sheet metal screws with plated finish

**FEATURES:**

- Beveled 3 or 4 sides optional
- Commercial grade thickness
- Other thicknesses available on special order
- Furnished with grain or satin finish running horizontally to door
- Finishes: 605, 606, 609, 612, 613, 619, 620, 626, 628, 629, 630, 670, Brass Tone (BT), Dark Anodized Aluminum (DB), Kydex, and **Endurance™**
- Plastic colors include: Black, Brown, Gray, Beige, White, Clear

**ORDERING:** Specify height x width x finish – add options (e.g.: 8" X 34" - 630, Tek)

**OPTIONS:**

- **MAG** - Magnetic backing for metal doors
- **SM** - Double face 3M Tape (Scotch Mount)
- **Tek** - Self drilling screws
- **CSK** - Countersunk holes
- **C/O** - Cutout for locks, louvers & windows
- **Torx** - Security torx screws
- **WH** - Warnock Hersey listed armor plates for fire rated 3 hour metal doors\*



\* Only available on .050 thick 630 plates  
Labelling only required when the top of the plate exceeds 16" in height

\*\* Some options carry additional charges.

NUMBER	MATERIAL
90	.050 Metal
91	.038 Metal
92	.125 Plastic
93	.125 Clear Plastic

**Warnock Hersey**



### New WARNOCK HERSEY LISTED ARMOR PLATES

We now offer Armor Plates for fire rated 3 hour metal doors. Please specify prefix "WH" when ordering (i.e. WH-48" x 48"-630). Screw mount only. There is a \$5.00 per plate additional charge.

## ANGLE PLATES

### TWO-SIDE

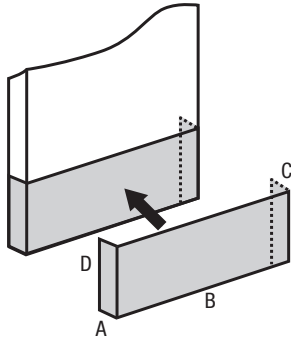

#1284 - Scotch Mount  
#1285 - Screw Mount

### ONE-SIDE

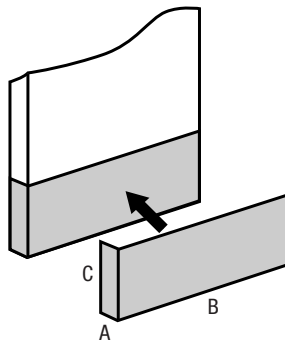

#1286 - Scotch Mount  
#1287 - Screw Mount

### BOTTOM SIDE

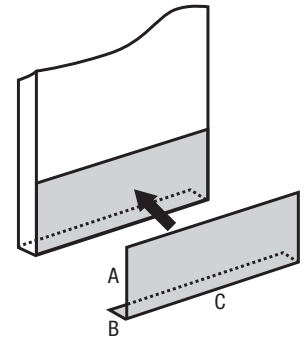

#1288 - Scotch Mount  
#1289 - Screw Mount

#### ORDERING:

2 SIDES: PART # x A (Leg Width) x B (Door Width) x C (Leg Width) x D (Height) x Finish

ONE SIDE: PART # x A (Leg Width) x B (Door Width) x C (Height) x Finish

BOTTOM SIDE: PART # x A (Height) x B (Bottom Width) x C (Door Width) x Finish

MATERIAL: .050" Thick Aluminum, Brass, Bronze, Stainless Steel

FASTENER: #6 x 5/8 FH SMS

FINISHES: Available in standard architectural finishes, prime painted steel

OPTIONS: Cutouts for flush bolts, lock strikes, locks, and hinges (see worksheet on page 4a for details on how to order.)

## CORNER GUARDS / U-CHANNELS

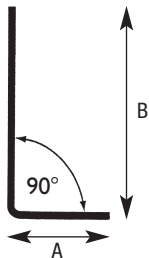

#1290 - Scotch Mount  
#1295 - Screw Mount  
ANSI 156.6 - J204

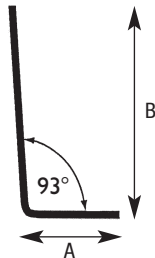

#1292 - Scotch Mount  
#1293 - Screw Mount  
ANSI 156.6 - J205

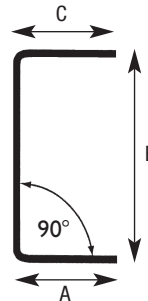

#1298 - Scotch Mount  
#1299 - Screw Mount  
ANSI 156.6 - J210

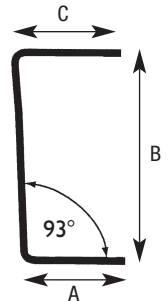

#1294 - Scotch Mount  
#1297 - Screw Mount  
ANSI 156.6 - J211

#### ORDERING:

CORNER GUARDS: PART # x A x B x HEIGHT

U-CHANNELS: PART # x A x B x C x HEIGHT

MATERIAL: .050" Thick Aluminum, Brass, Bronze, Stainless Steel

FASTENER: #6 x 5/8 FH SMS

FINISHES: Available in standard architectural finishes, prime painted steel

OPTIONS:

- Cutouts for flush bolts, lock strikes, locks, and hinges (see worksheet on page 4a)
- 10° return on legs available upon request

OVERLAPPING CORNER GUARDS / U-CHANNELS

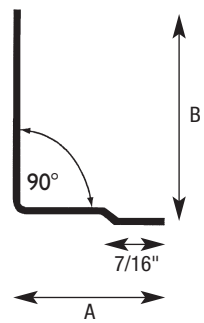

**#1310 - Scotch Mount**  
**#1311 - Screw Mount**  
 ANSI 156.6 - J201

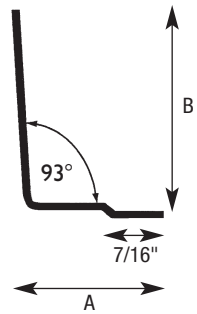

**#1312 - Scotch Mount**  
**#1313 - Screw Mount**  
 ANSI 156.6 - J202

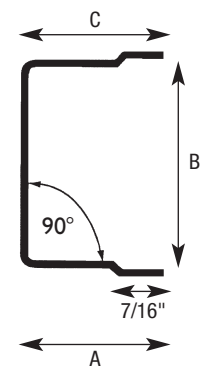

**#1314 - Scotch Mount**  
**#1315 - Screw Mount**  
 ANSI 156.6 - J207

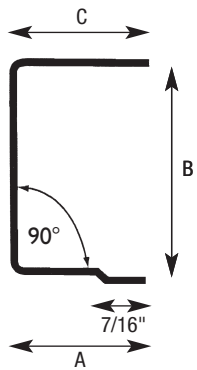

**#1316 - Scotch Mount**  
**#1317 - Screw Mount**  
 ANSI 156.6 - J207

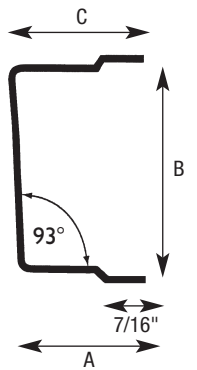

**#1318 - Scotch Mount**  
**#1319 - Screw Mount**  
 ANSI 156.6 - J208

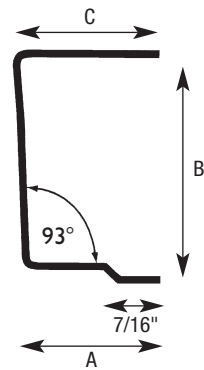

**#1320 - Scotch Mount**  
**#1321 - Screw Mount**  
 ANSI 156.6 - J208

**ORDERING:**

**CORNER GUARDS: PART # / A x B x HEIGHT**

**U-CHANNELS: PART # / A x B x C x HEIGHT**

**OVERLAPPING OFFSET: 1/16"**

**MATERIAL:** .050" Thick Aluminum, Brass, Bronze, Plain Steel, Stainless Steel



**FASTENER:** #6 x 5/8 FH SMS

**FINISHES:** Available in standard architectural finishes, prime painted steel

- OPTIONS:**
- Cutouts for flush bolts, lock strikes, locks, and hinges (see worksheet on page 4a)
  - 10° return available upon request

## How to Specify Cut-Out Locations

This drawing shows typical location of cutouts for full length door edges on lock edge of doors. Use this page as a worksheet or photocopy and fill in your dimensions.

LH				
	#XXXX	#XXXX	#XXXX	#XXXX
RH				
	#XXXX	#XXXX	#XXXX	#XXXX

**Top of Typical Metal Door**

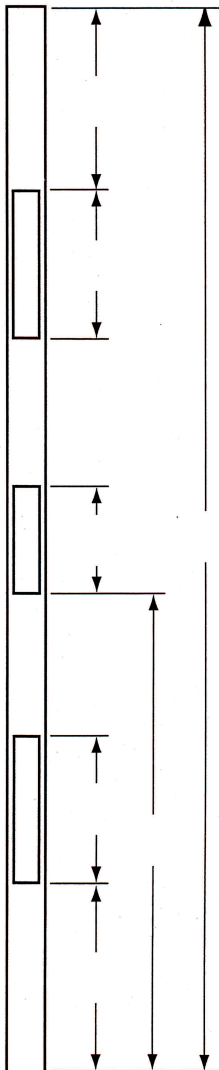

**Top of Typical Wood Door**

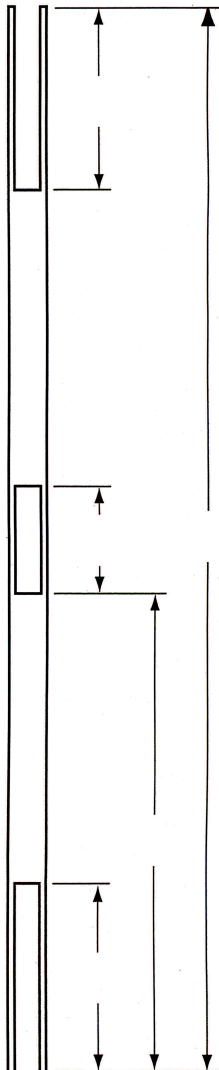

**For Use on 1 3/4" Doors**

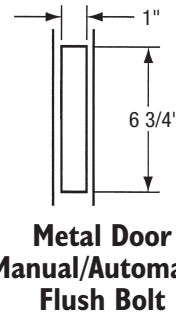
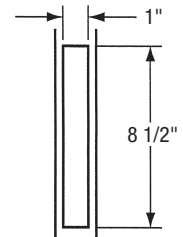
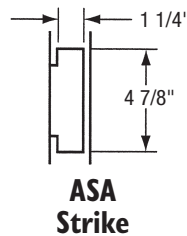
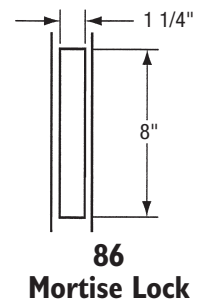
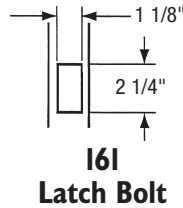

**Wood Door Manual Flush Bolt**

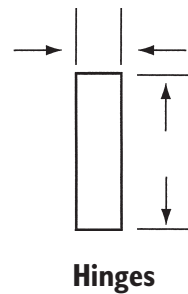

## VERTICAL ROD PROTECTOR

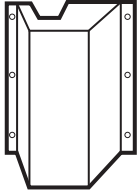
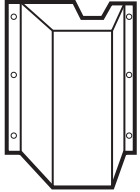

NUMBER	DESCRIPTION	WIDTH	HEIGHT	PROJECTION	MATERIAL
81	Latch bolt cover	6 3/4"	10"	2 1/8"	Stainless steel
83	Latch bolt cover	6 3/4"	10"	2 1/8"	Stainless steel
85	Rod cover	3 1/8"	24"	1 1/8"	Stainless steel

SHELF PACK: 1

Box Pack

GAUGE: 18 (.050)

FASTENERS: #6 X 3/4"

- FEATURES:
- Assist in handicap conformance
  - Use in hospitals, schools, etc.
  - Installs on any type of wood, metal or plastic door, any thickness.
- Covers the latching bolt and lower portion of the vertical rod assembly.

FINISH: 630

**#81**

For use on right hand reverse doors

**#83**

For use on left hand reverse doors

**#85**

Rod Cover

## RANGE SHIELDS



RS2430

NUMBER	DIMENSIONS
RS2430	24" x 30"

SHELF PACK: 4

Box Pack

GAUGE: 22 (.032)

FASTENERS: #6 x 5/8" SMS

FINISHES: White, Almond

## DISPLAY PACKAGED KICK PLATES

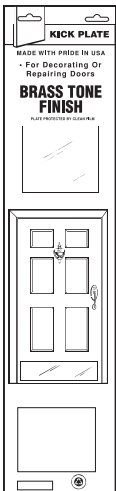

Innovative packaging includes an outer corrugation that insures the inner package will remain fresh for display. Package allows for hanging or stacking.

- Furnished with grain or satin finish running horizontally to door
- Finishes: 605, 628, 630, Brass Tone (BT)
- Individually packaged with screws #6 x 5/8 SMS
- Full threaded to the head stainless steel sheet metal screws with plated finish

NUMBER	DIMENSIONS
KP-628	6" x 28"
KP-630	6" x 30"
KP-632	6" x 32"
KP-634	6" x 34"
KP-828	8" x 28"
KP-830	8" x 30"
KP-832	8" x 32"
KP-834	8" x 34"

SHELF PACK: 1

Display Packaged Size - 8 1/4" x 38 1/2"