

CLASSIC WRAP-AROUNDS

For **CYLINDRICAL DOOR LOCKS** with 2 1/8" hole

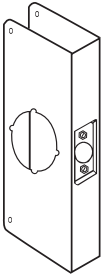

- 1-CW**
- 2-CW**
- 3-CW**
- 4-CW**

NUMBER	BACKSET	DOOR	DIMENSIONS
1-CW	2 3/8"	1 3/8"	4" x 9"
2-CW	2 3/8"	1 3/4"	4" x 9"
3-CW	2 3/4"	1 3/8"	4 1/4" x 9"
4-CW	2 3/4"	1 3/4"	4 1/4" x 9"

SHELF PACK: 1

Box Size - 4 1/2" x 9 3/4"

GAUGE: 22 (.032)

CW comes box packaged as standard.

FINISHES: 10B (613), AB (609), BZ (612), PB (605), S (630)

Display Packaged also available. When ordering indicate by replacing the letters "CW" with "V" after the item number.

Display Package Size - 5 1/4" x 11"

For **DEADBOLTS** with 1 1/2" hole

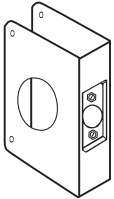

- 5-CW**
- 6-CW**
- 7-CW**
- 8-CW**

NUMBER	BACKSET	DOOR	DIMENSIONS
5-CW	2 3/8"	1 3/8"	4" x 4 1/2"
6-CW	2 3/8"	1 3/4"	4" x 4 1/2"
7-CW	2 3/4"	1 3/8"	4 1/4" x 4 1/2"
8-CW	2 3/4"	1 3/4"	4 1/4" x 4 1/2"

SHELF PACK: 1

Box Size - 5 1/4" x 4 1/2"

GAUGE: 22 (.032)

CW comes box packaged as standard.

FINISHES: 10B (613), AB (609), BZ (612), PB (605), S (630)

Display Packaged also available. When ordering indicate by replacing the letters "CW" with "V" after the item number.

Display Package Size - 5 1/4" x 6 1/2"

For **CYLINDRICAL DOOR LOCKS** with 2 1/8" hole

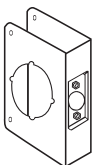

- 51-CW**
- 61-CW**
- 71-CW**
- 81-CW**

NUMBER	BACKSET	DOOR	DIMENSIONS
51-CW	2 3/8"	1 3/8"	4" x 4 1/2"
61-CW	2 3/8"	1 3/4"	4" x 4 1/2"
71-CW	2 3/4"	1 3/8"	4 1/4" x 4 1/2"
81-CW	2 3/4"	1 3/4"	4 1/4" x 4 1/2"

SHELF PACK: 1

Box Size - 5 1/4" x 4 1/2"

GAUGE: 22 (.032)

CW comes box packaged as standard.

FINISHES: 10B (613), AB (609), BZ (612), PB (605), S (630)

Display Packaged also available. When ordering indicate by replacing the letters "CW" with "V" after the item number.

Display Package Size - 5 1/4" x 6 1/2"

For **DOUBLE LOCK COMBINATION LOCKSETS** with 1 1/2" hole on top and 2 1/8" hole on bottom with 4" centers

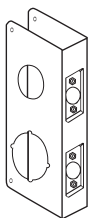

**154-CW
264-CW
484-CW**

NUMBER	BACKSET	DOOR	DIMENSIONS
154-CW	2 3/8"	1 3/8"	4" x 9"
264-CW	2 3/8"	1 3/4"	4" x 9"
484-CW	2 3/4"	1 3/4"	4 1/4" x 9"

SHELF PACK: 1

Box Size - 4 1/2" x 9 3/4"

GAUGE: 22 (.032)

CW comes box packaged as standard.

FINISHES: IOB (613), AB (609), BZ (612), PB (605), S (630)

Display Packaged also available. When ordering indicate by replacing the letters "CW" with "V" after the item number.

Display Package Size - 5 1/4" x 11"

For **DOUBLE LOCK COMBINATION LOCKSETS** with 2 1/8" holes with 5 1/2" centers

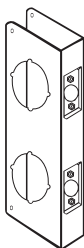

**256-CW
258-CW**

NUMBER	BACKSET	DOOR	DIMENSIONS
256-CW	2 3/8"	1 3/4"	4" x 12"
258-CW	2 3/4"	1 3/4"	4 1/4" x 12"

SHELF PACK: 1

Box Pack

GAUGE: 22 (.032)

FINISHES: IOB (613), AB (609), BZ (612), PB (605), S (630)

For **CYLINDER DOOR LOCKS** with 2 1/8" hole, 12" height

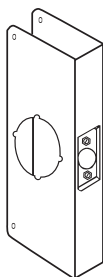

12-CW

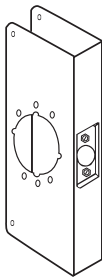

12-2-CW

NUMBER	BACKSET	DOOR	DIMENSIONS
12-CW	2 3/4"	1 3/4"	4 1/4" x 12"
12-2-CW	2 3/4"	1 3/4"	4 3/4" x 12"

SHELF PACK: 1

Box Pack

GAUGE: 22 (.032)

FINISHES: IOB (613), PB (605), S (630)

For **DOUBLE LOCK COMBINATION LOCKSETS** with 2 1/8" holes with 3 5/8" centers

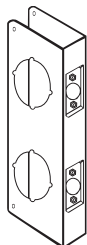

**151-CW
261-CW
481-CW**

NUMBER	BACKSET	DOOR	DIMENSIONS
151-CW	2 3/8"	1 3/8"	4" x 9"
261-CW	2 3/8"	1 3/4"	4" x 9"
481-CW	2 3/4"	1 3/4"	4 1/4" x 9"

SHELF PACK: 1

Box Size - 4 1/2" x 9 3/4"

GAUGE: 22 (.032)

CW comes box packaged as standard.

FINISHES: IOB (613), AB (609), BZ (612), PB (605), S (630)

Display Packaged also available. When ordering indicate by replacing the letters "CW" with "V" after the item number.

Display Package Size - 5 1/4" x 11"

For DOUBLE LOCK COMBINATION LOCKSETS with 2 1/8" holes with 4" centers

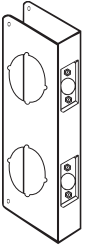

942-CW
943-CW

NUMBER	BACKSET	DOOR	DIMENSIONS
942-CW	2 3/8"	1 3/4"	4" x 9"
943-CW	2 3/4"	1 3/4"	4 1/4" x 9"

SHELF PACK: I

Box Size - 4 1/2" x 9 3/4"

GAUGE: 22 (.032)

CW comes box packaged as standard.

FINISHES: IOB (613), AB (609), BZ (612), PB (605), S (630)

Display Packaged also available. When ordering indicate by replacing the letters "CW" with "V" after the item number.

Display Package Size - 5 1/4" x 11"

For DOUBLE LOCK COMBINATION LOCKSETS with 6" centers

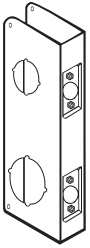

486-CW
hole sizes
1 1/2" over 2 1/8"

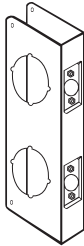

946-CW
hole sizes
2 1/8" over 2 1/8"

NUMBER	BACKSET	DOOR	DIMENSIONS
486-CW	2 3/4"	1 3/4"	4 1/2" x 12"
946-CW	2 3/4"	1 3/4"	4 1/2" x 12"

SHELF PACK: I

Box Pack

GAUGE: 22 (.032)

FINISHES: IOB (613), PB (605), S (630)

BLANK WRAP-AROUND with TRIM SCREWS

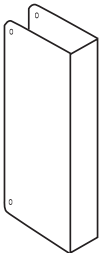

30-CW
40-CW
70-CW
80-CW
90-CW

NUMBER	DOOR	DIMENSIONS
30-CW	1 3/8"	4 1/4" x 9"
40-CW	1 3/4"	4 1/4" x 9"
70-CW	1 3/8"	4 1/4" x 4 1/2"
80-CW	1 3/4"	4 1/4" x 4 1/2"
90-CW	1 3/4"	5" x 12"

Display Packaged also available. When ordering indicate by replacing the letters "CW" with "V" after the item number.

Display Package Size - 5 1/4" x 11" and 5 1/4" x 6 1/2"

SHELF PACK: I

GAUGE: 22 (.032)

Box Size - 5 1/4" x 4 1/2" and 4 1/2" x 9 3/4"

CW comes box packaged as standard.

90-CW Box Pack Only

FINISHES: IOB (613), AB (609), BZ (612), PB (605), S (630)

20" WRAP-AROUND

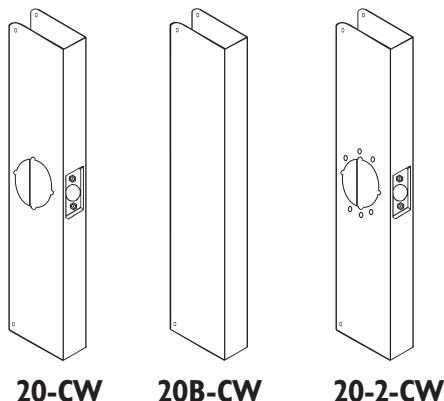

NUMBER	BACKSET	DOOR	DIMENSIONS
20-CW	2 3/4"	1 3/4"	5" x 20"
20B-CW	—	1 3/4"	5" x 20"
20C-CW	2 3/8"	1 3/4"	5" x 20"
20-2-CW	2 3/4"	1 3/4"	5 3/4" x 20"

SHELF PACK: 1 Box Pack
 GAUGE: 22 (.032)
 FEATURES: • Beveled front
 • Non-handed
 FINISHES: 10B (613), PB (605), S (630)

For installing the MARKS LEVERS

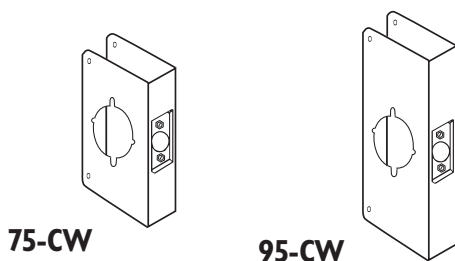

NUMBER	BACKSET	DOOR	DIMENSIONS
75-CW	2 3/4"	1 3/4"	4 3/4" x 5 1/2"
95-CW	2 3/4"	1 3/4"	4 3/4" x 9"

SHELF PACK: 1 Box Pack
 GAUGE: 22 (.032)
 FINISHES: 10B (613), AB (609), BZ (612), PB (605), S (630)

For installing the BEST AND SARGENT LEVER LOCKS

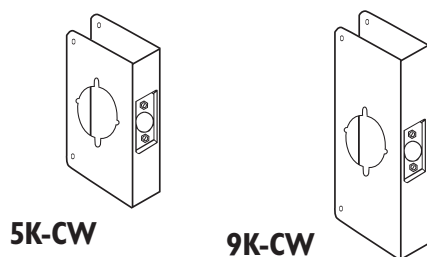

NUMBER	BACKSET	DOOR	DIMENSIONS
5K-CW	2 3/4"	1 3/4"	4 3/4" x 5 1/2"
9K-CW	2 3/4"	1 3/4"	4 3/4" x 9"

SHELF PACK: 1 Box Pack
 GAUGE: 22 (.032)
 FINISHES: 10B (613), AB (609), BZ (612), PB (605), S (630)

For use with HEAVY DUTY GRADE 1 & GRADE 2 key-in-levers

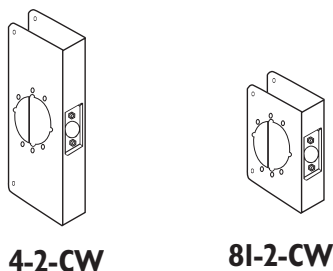

NUMBER	BACKSET	DOOR	DIMENSIONS
4-2-CW	2 3/4"	1 3/4"	4 3/4" x 9"
81-2-CW	2 3/4"	1 3/4"	4 3/4" x 4 1/2"

SHELF PACK: 1 Box Pack
 GAUGE: 22 (.032)
 FEATURES: Works with Schlage, Arrow, Yale, Sargent, Corbin Russwin and Falcon T
 FINISHES: 10B (613), AB (609), BZ (612), PB (605), S (630)

For KABA/SIMPLEX 1000, E-2000, 4000 & 5000 SERIES

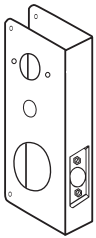

9-CW

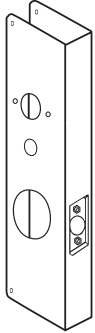

15-CW

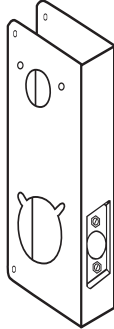

4000-CW

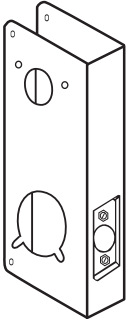

5000-CW

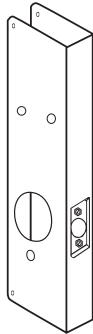

E-2000-CW

NUMBER	BACKSET	DOOR	DIMENSIONS
9-CW	2 3/4"	1 3/4"	5" x 9"
15-CW	2 3/4"	1 3/4"	5" x 15"
4000-2-CW	2 3/8"	1 3/4"	5" x 15"
4000-4-CW	2 3/4"	1 3/4"	5" x 15"
5000-CW	2 3/4"	1 3/4"	5" x 15"
E2000-CW	2 3/4"	1 3/4"	5" x 15"

SHELF PACK: I

Box Pack

GAUGE: 22 (.032)

FEATURES: (9-CW & 15-CW) Works with Simplex 1000 Lock
 (E2000-CW) Works with Simplex E-2000 Lock
 (4000-CW) Works with Simplex 4000 Lock
 (5000-CW) Works with Simplex 5000 Lock

FINISHES: (9-CW, 15-CW, 4000-2-CW, 4000-4-CW) IOB (613), AB (609), PB (605), S (630)
 (5000-CW) IOB (613), PB (605), S (630)
 (E2000-CW) IOB (613), PB (605), S (630)

For ALARM LOCK 2700/T2, 3000 & DL 4100 SERIES TRILOGY LOCK

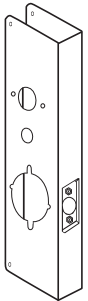

27-CW

NUMBER	BACKSET	DOOR	DIMENSIONS
27-CW	2 3/4"	1 3/4"	5" x 15"

SHELF PACK: I

Box Pack

GAUGE: 22 (.032)

FINISHES: (27-CW) IOB (613), AB (609), PB (605), S (630)

For SECURITRON SABLE LOCK

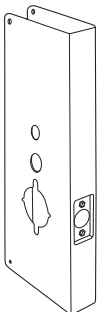

28-CW

NUMBER	BACKSET	DOOR	DIMENSIONS
28-CW	2 3/4"	1 3/4"	5" x 15"

SHELF PACK: I

Box Pack

GAUGE: 22 (.032)

FEATURES: Works with Securitron Sable Lock

FINISHES: (28-CW) IOB (613), PB (605), S (630)

For BEST 93-KV LOCKS & MAS-HAMILTON POWER LEVERS

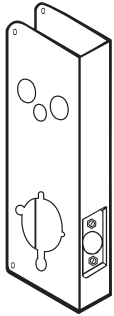

93-KV-CW

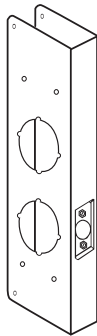

16-CW

NUMBER	BACKSET	DOOR	DIMENSIONS
93-KV-CW	2 3/4"	1 3/4"	5 1/2" x 12 3/4"
16-CW	2 3/4"	1 3/4"	5" x 15"

SHELF PACK: I Box Pack
 GAUGE: 22 (.032)
 FINISHES: 10B (613), PB (605), S (630)

For ARROW REVOLUTION AND YALE IN TOUCH LOCKS

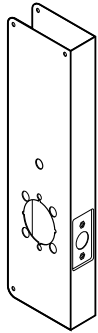

25-CW

NUMBER	BACKSET	DOOR	DIMENSIONS
25-CW	2 3/4"	1 3/4"	5 1/8" x 15"

SHELF PACK: I Box Pack
 GAUGE: 22 (.032)
 FINISHES: 10B (613), PB (605), S (630)

For SCHLAGE COBRA LOCKS

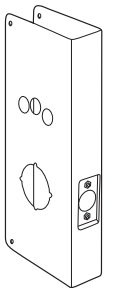

17-CW

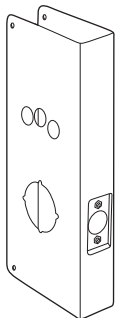

18-CW

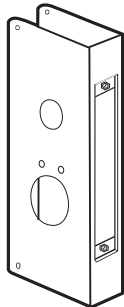

518-CW

NUMBER	BACKSET	DOOR	DIMENSIONS
17-CW	2 3/4"	1 3/4"	5" x 12"
18-CW	2 3/4"	1 3/4"	5" x 15"
518-CW	2 3/4"	1 3/4"	5" x 12"

SHELF PACK: I Box Pack
 GAUGE: 22 (.032)
 FEATURES: Works with Schlage King Cobra Cylindrical and Mortise Lock
 FINISHES: (17-CW, 18-CW) 10B (613), BZ (612), PB (605), S (630)
 (518-CW) 10B (613), PB (605), S (630)

For SCHLAGE PRO SERIES

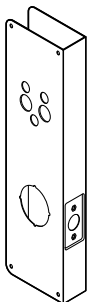

5100-CW

NUMBER	BACKSET	DOOR	DIMENSIONS
5100-CW	2 3/4"	1 3/4"	5 1/8" x 15"

SHELF PACK: I Box Pack
 GAUGE: 22 (.032)
 FEATURES: Works with Schlage/Locknetics pro series
 FINISHES: 10B (613), PB (605), S (630)

For MARKS I-Q LOCKS

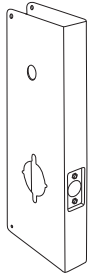

19-CW

NUMBER	BACKSET	DOOR	DIMENSIONS
19-CW	2 3/4"	1 3/4"	5" x 15"

SHELF PACK: I **Box Pack**
GAUGE: 22 (.032)
FINISHES: 10B (613), PB (605), S (630)

For CODELOCKS 2010, 4010 & 5000 SERIES

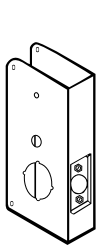

21-CW

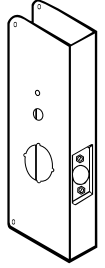

22-CW

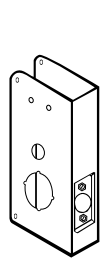

23-CW

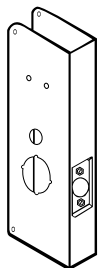

24-CW

NUMBER	BACKSET	DOOR	DIMENSIONS
21-CW	2 3/8"	1 3/4"	5" x 9"
22-CW	2 3/8"	1 3/4"	5" x 15"
23-CW	2 3/4"	1 3/4"	5" x 9"
24-CW	2 3/4"	1 3/4"	5" x 15"

SHELF PACK: I **Box Pack**
GAUGE: 22 (.032)
FEATURES: (21-CW, 22-CW) Work with 2010 and 4010 series lock
(23-CW, 24-CW) Work with 5000 series lock
FINISHES: 10B (613), PB (605), S (630)

For conversion of SIMPLEX 1000 SERIES & ALARM LOCK DL2500, 2700/T2 & 3000 SERIES

to key-in-knob lock

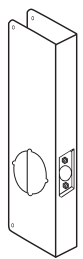

14-CW

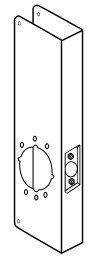

14-2-CW

NUMBER	BACKSET	DOOR	DIMENSIONS
14-CW	2 3/4"	1 3/4"	5" x 14"
14-2-CW	2 3/4"	1 3/4"	5" x 14"

SHELF PACK: I **Box Pack**
GAUGE: 22 (.032)
FINISHES: 10B (613), AB (609), PB (605), S (630)

MORTISE LOCK wrap-around plate for 86 cut-out

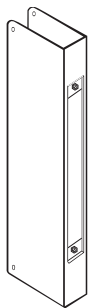

504-CW

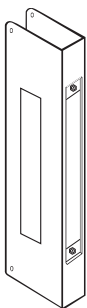

514-CW

NUMBER	BACKSET	DOOR	DIMENSIONS
504-CW	—	1 3/4"	5" x 12"
514-CW	2 3/4"	1 3/4"	5" x 12"

SHELF PACK: 1

Box Pack

GAUGE: 22 (.032)

- FEATURES:**
- 8" x 1 1/4" Recess
 - Drill spindle and thumb turn holes in field
 - Rectangle size 1 5/8" x 7 5/16"
 - 8" x 1 1/4" Recess

FINISHES: IOB (613), BZ (612), PB (605), S (630)

For CONVERTING UNIT LOCKS to LEVER LOCKS

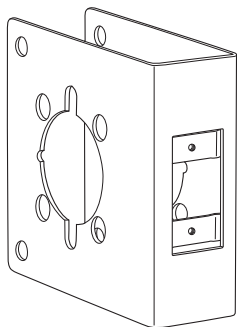

NUMBER	BACKSET	DOOR	DIMENSIONS
4U-2-CW	2 3/4"	1 3/4"	4 1/2" x 5"

SHELF PACK: 1

Box Pack

GAUGE: 13 (.095) heavy gauge material

- FEATURES:**
- Converts unit locks to lever locks
 - Prepped to accept grade 1 & 2 levers
 - Sex bolts used to secure plate to door

FINISHES: BP, DU, S

For MOUNTING DON-JO HOSPITAL PUSH/PULL LATCHES

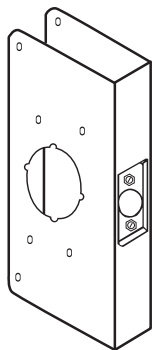

**4500-CW
4550-CW**

NUMBER	BACKSET	DOOR	DIMENSIONS
4500-CW	2 3/4"	1 3/4"	4 3/4" x 9"
4550-CW	5"	1 3/4"	6 1/2" x 9"

SHELF PACK: 1

Box Pack

GAUGE: 22 (.032)

FEATURES: Also works with ABH 6100 Series, Glenn Johnson HL6 & Hager 311

FINISHES: IOB (613), PB (605), S (630)

For LOCKS with EXTENDED or CONVERTED BACKSETS

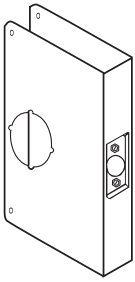

Extended
33-CW
55-CW

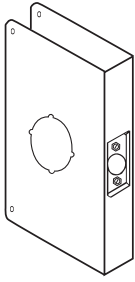

Converted
33A-CW
55A-CW

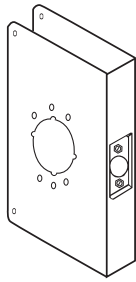

Converted
33A-2-CW
55A-2-CW

NUMBER	BACKSET	DOOR	DIMENSIONS
33-CW	3 3/4"	1 3/4"	5 1/2" x 9"
33A-2-CW	2 3/4"	1 3/4"	6 1/2" x 9"
33A-CW	2 3/4"	1 3/4"	6 1/2" x 9"
55-CW	5"	1 3/4"	6 1/2" x 9"
55A-2-CW	2 3/4"	1 3/4"	6 1/2" x 9"
55A-CW	2 3/4"	1 3/4"	6 1/2" x 9"

SHELF PACK: 1

Box Pack

GAUGE: 22 (.032)

FINISHES: 10B (613), AB (609), BZ (612), PB (605), S (630)

For THICKER DOORS

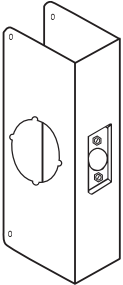

200-CW
200C-CW
212-CW
212C-CW
214-CW
214C-CW

NUMBER	BACKSET	DOOR	DIMENSIONS
200-CW	2 3/4"	2"	4 1/4" x 9"
200C-CW	2 3/8"	2"	4 1/4" x 9"
212-CW	2 3/4"	2 1/2"	4 1/4" x 9"
212C-CW	2 3/8"	2 1/2"	4 1/4" x 9"
214-CW	2 3/4"	2 1/4"	4 1/4" x 9"
214C-CW	2 3/8"	2 1/4"	4 1/4" x 9"

SHELF PACK: 1

Box Pack

GAUGE: 22 (.032)

FEATURES: • Latch hole centered in door
• Available with lever Prep. - Custom order only

FINISHES: 10B (613), PB (605), S (630)

DOOR REINFORCER for deadbolts & key-in-knob locks

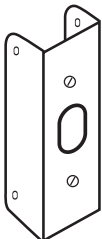

10-FE
20-FE

NUMBER	BACKSET	DOOR	DIMENSIONS
10-FE	—	1 3/8"	4 1/2" x 1"
20-FE	—	1 3/4"	4 1/2" x 1"

SHELF PACK: 10

Display Package Size - 4" x 7 3/4"

GAUGE: 22 (.032)

FINISHES: 10B (613), AB (609), PB (605), S (630)

