

The INTERLOCK for inswinging doors

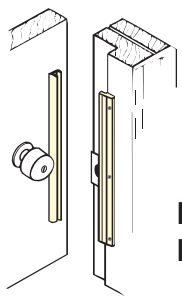

ILP-206
ILP-212

NUMBER	DIMENSIONS	MATERIAL
ILP-206	6"	Steel
ILP-212	12"	

SHELF PACK: 10 Display Package Size - 4" x 12" and 4" x 16"
GAUGE: 14 (.075)
FEATURES: • 6" version for use with key-in-knob and deadbolt locks
 • 12" version for use with Mortise Locks, Simplex 1000 series, Alarm Lock DL-2500, DL-2700 & 3000, Card Access Systems, etc.
FINISHES: BP (Brass Plated), CP (Chrome Plated), DU (Duro Coated), SL (Silver Coated)

For ALUMINUM ENTRANCE doors

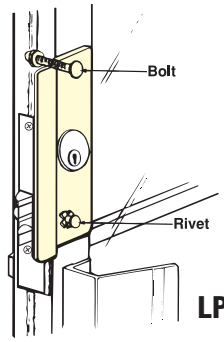

LP-307

NUMBER	DIMENSIONS	MATERIAL
LP-307	2 5/8" x 7"	Steel Stainless Steel

SHELF PACK: 10 Polybagged / Display Package Size 4" x 12"
GAUGE: 12 (.104)
FEATURES: • Reversible • Fits over cylinder - lock removal NOT required
 • Hand carriage bolt and rivet supplied • No specific tools required
 • 3/8" offset
FINISHES: 630, DU (Duro Coated), SL (Silver Coated)

For ALUMINUM ENTRANCE doors- solves pull handle interference

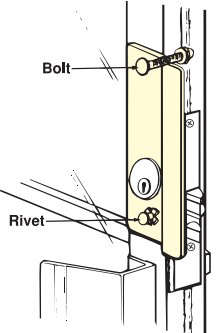

GLP-307
LHR SHOWN

NUMBER	DIMENSIONS	MATERIAL
GLP-307 LHR	2 5/8" x 7"	Steel Stainless Steel
GLP-307 RHR	2 5/8" x 7"	

SHELF PACK: 10 Polybagged
GAUGE: 12 (.104)
FEATURES: • Fits over cylinder - lock removal NOT required
 • Hand carriage bolt and rivet supplied • No specific tools required
 • 3/8" offset
 • Center of cylinder hole is 2 1/2" from end of plate
FINISHES: 630, DU (Duro Coated), SL (Silver Coated)

For use with CENTER HUNG OUTSWINGING ALUMINUM doors

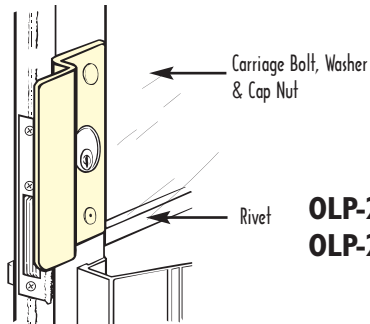

OLP-2650
OLP-2651

NUMBER	DIMENSIONS	MATERIAL
OLP-2650	2 5/8" x 6 1/2"	Steel
OLP-2651	2 5/8" x 6 1/2"	

SHELF PACK: 10 Polybagged
GAUGE: 12 (.104)
FEATURES: • (OLP-2650) available in 1 1/8" offset
 • (OLP-2651) available in 1 3/8" offset
FINISHES: DU (Duro Coated), SL (Silver Coated)

 **EBF Fasteners available with selected Latch Protectors.**

America's favorite for **OUTSWINGING DOORS** - completely covers the strike plate

NUMBER	DIMENSIONS	MATERIAL
MLP-111	3" x 11"	Stainless Steel
MLP-211	3" x 11"	Steel
MLP-111-EBF	3" x 11"	Stainless Steel
MLP-211-EBF	3" x 11"	Steel

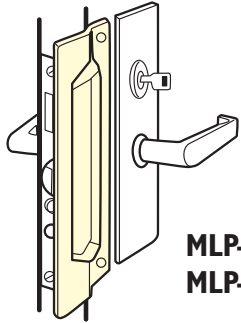

**MLP-III
MLP-211**

SHELF PACK: 10 Polybagged
GAUGE: 12 (.104)
FEATURES: (MLP-111, MLP-211) Furnished with carriage bolts, washers & acorn cap nuts for safety and strength
 (MLP-111-EBF, MLP-211-EBF) Furnished w/carriage bolt & sex nut
FINISHES: (MLP-111) 630
 (MLP-211) BP (Brass Plated), CP (Chrome Plated), DU (Duro Coated), SL (Silver Coated)

America's favorite for **OUTSWINGING DOORS** - completely covers the strike plate

NUMBER	DIMENSIONS	MATERIAL
LP-111	3" x 11"	Stainless Steel
LP-211	3" x 11"	Steel
9211 (*Polybagged)	3" x 11"	Steel
LP-111-EBF	3" x 11"	Stainless Steel
LP-211-EBF	3" x 11"	Steel
9211 (*Polybagged)-EBF	3" x 11"	Steel

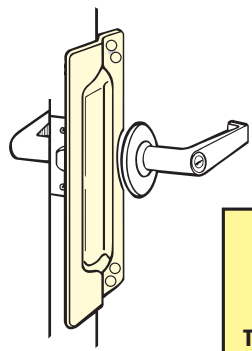

SAVE \$!
 Product available polybagged
 To order, replace "LP" with "9". (i.e., LP-211 will become 9211)

**LP-III
LP-211
9211**

SHELF PACK: 10 Display Package Size - 4" x 16" (9211, LP-111) Polybagged
GAUGE: 12 (.104)
FEATURES: • Furnished with carriage bolts, washers & acorn cap nuts for safety and strength
 • Fits 2 3/4" and 2 3/8" backsets
FINISHES: (LP-111) 630
 (LP-211) BP (Brass Plated), CP (Chrome Plated), DU (Duro Coated), PC (Prime Coated), SL (Silver Coated)

Pin Latch protectors for **OUTSWINGING DOORS**

NUMBER	DIMENSIONS	MATERIAL
PLP-111	3" x 11"	Stainless Steel
PLP-211	3" x 11"	Steel
PLP-111-EBF	3" x 11"	Stainless Steel
PLP-211-EBF	3" x 11"	Steel

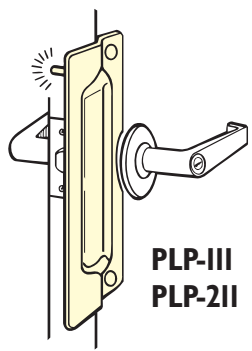

**PLP-III
PLP-211**

SHELF PACK: 10 Polybagged
GAUGE: 12 (.104)
FEATURES: • Solid steel pin prevents spreading of door from frame
 • Pin is welded on back leaving no visible point of attack from outside
 • Fits 2 3/4" and 2 3/8" backsets
FINISHES: (PLP-111) 630
 (PLP-211) 626, BP (Brass Plated), CP (Chrome Plated), DU (Duro Coated), SL (Silver Coated),



EBF Fasteners available with selected Latch Protectors.

Pin Latch protectors for OUTSWINGING DOORS

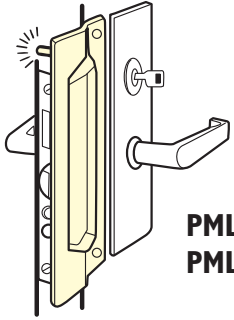

**PMLP-III
PMLP-2II**

NUMBER	DIMENSIONS	MATERIAL
PMLP-111	3" x 11"	Stainless Steel
PMLP-211	3" x 11"	Steel
PMLP-111-EBF	3" x 11"	Stainless Steel
PMLP-211-EBF	3" x 11"	Steel

SHELF PACK: 10

Polybagged

GAUGE: 12 (.104)

FEATURES: • Solid steel pin prevents spreading of door from frame
• Pin is welded on back leaving no visible point of attack from outside

FINISHES: (PMLP-111) 630

(PMLP-211) BP (Brass Plated), CP (Chrome Plated), DU (Duro Coated), SL (Silver Coated)

For Outswinging doors

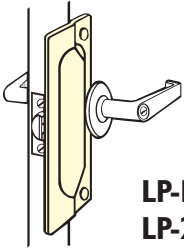

**LP-107
LP-207**

NUMBER	DIMENSIONS	MATERIAL
LP-107	2 3/4" x 7"	Stainless Steel
LP-207	2 3/4" x 7"	Steel
LP-107-EBF	2 3/4" x 7"	Stainless Steel
LP-207-EBF	2 3/4" x 7"	Steel

SHELF PACK: 10

Display Package Size - 4" x 12"

GAUGE: 12 (.104)

FEATURES: Furnished with carriage bolts, washers & acorn cap nuts for safety and strength

FINISHES: (LP-107) 630

(LP-207) BP (Brass Plated), CP (Chrome Plated), DU (Duro Coated), SL (Silver Coated)

COMMERCIAL TYPE for outswinging doors

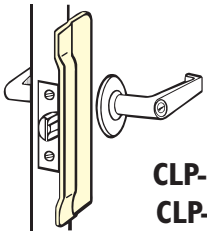

**CLP-106
CLP-110**

NUMBER	DIMENSIONS	MATERIAL
CLP-106	2 1/8" x 6"	Stainless Steel
CLP-110	2 1/8" x 10"	

SHELF PACK: 10

Polybagged

GAUGE: 12 (.104)

FEATURES: • 6" for key-in-knobs • 10" for Mortise Locks

• Architectural design • Concealed welded studs with fasteners

FINISHES: 630

ANGLE TYPE for outswinging doors

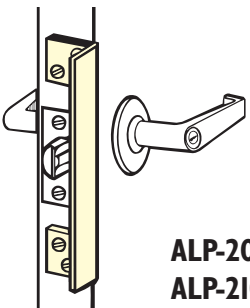

**ALP-206
ALP-210**

NUMBER	DIMENSIONS	MATERIAL
ALP-206	6"	Steel
ALP-210	10"	

SHELF PACK: 10

Polybagged

GAUGE: 10 (.134)

FEATURES: • 6" for key-in-knobs

• 10" for Mortise Locks

• 1 1/2" sheet metal screws for wood or metal

FINISHES: BC (Brass Coated), DU (Duro Coated), SL (Silver Coated)

NARROW COMMERCIAL TYPE for outswinging doors

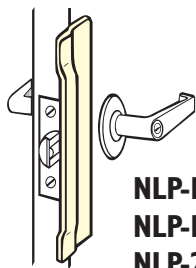

NLP-106
NLP-110
NLP-206
NLP-210

NUMBER	DIMENSIONS	MATERIAL
NLP-106	1 1/2" x 6"	Stainless Steel
NLP-110	1 1/2" x 10"	
NLP-206	1 1/2" x 6"	Steel
NLP-210	1 1/2" x 10"	

SHELF PACK: 10 Polybagged

GAUGE: 12 (.104)

FEATURES: • 6" for key-in-knobs • 10" for Mortise Locks
• Narrow type for outswinging doors

FINISHES: (NLP-106, NLP-110) 630
(NLP-206, NLP-210) DU (Duro Coated), PC (Prime Coated), SL (Silver Coated)

For KEY-IN-LEVER Locks with up to 3 3/4" ESCUTCHEON

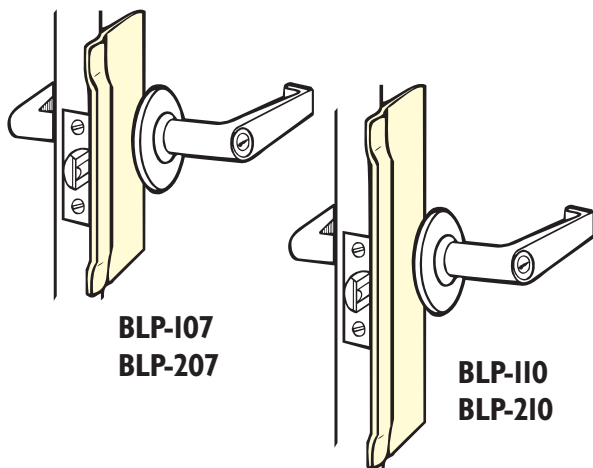

BLP-107
BLP-207

BLP-110
BLP-210

NUMBER	DIMENSIONS	MATERIAL
BLP-107	3 1/4" x 7"	Stainless Steel
BLP-110	3 1/4" x 10"	
BLP-207	3 1/4" x 7"	Steel
BLP-210	3 1/4" x 10"	

SHELF PACK: 10 Polybagged

GAUGE: 12 (.104)

FEATURES: • Works with up to 3 3/4" rose
• Concealed welded studs with fasteners

FINISHES: (BLP-107, BLP-110) 630
(BLP-207, BLP-210) BP (Brass Plated), DU (Duro Coated), SL (Silver Coated)

For ELECTRONIC Locks

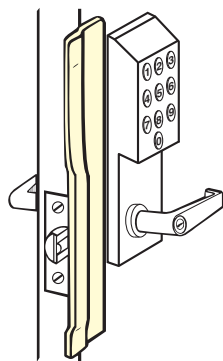

"RHR" SHOWN

KLP-110-LHR
KLP-110-RHR

NUMBER	DIMENSIONS	MATERIAL
KLP-110-LHR	1 1/2" x 10"	Stainless Steel
KLP-110-RHR	1 1/2" x 10"	

SHELF PACK: 10 Polybagged

GAUGE: 12 (.104)

FEATURES: • Works with ILCO 1000, 4000
• Alarm Lock Trilogy Locks
• Mas-Hamilton Power Levers
• Schlage Cobra
• Marks I-Q

FINISHES: 630



EBF Fasteners available with selected Latch Protectors.

SHORT TYPE for outswinging doors

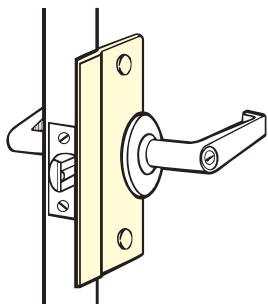

**SLP-106
SLP-206**

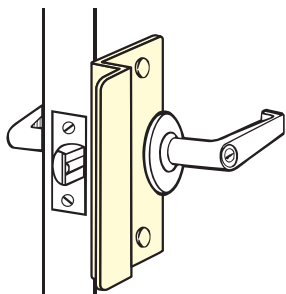

**OSLP-110
OSLP-210**

NUMBER	DIMENSIONS	MATERIAL
SLP-106	2 5/8" x 6"	Stainless Steel
SLP-206	2 5/8" x 6"	Steel
OSLP-107	2 5/8" x 7"	Stainless Steel
OSLP-207	2 5/8" x 7"	Steel
OSLP-110	2 5/8" x 10"	Stainless Steel
OSLP-210	2 5/8" x 10"	Steel
SLP-106-EBF	2 5/8" x 6"	Stainless Steel
SLP-206-EBF	2 5/8" x 6"	Steel
OSLP-107-EBF	2 5/8" x 7"	Stainless Steel
OSLP-207-EBF	2 5/8" x 7"	Steel
OSLP-110-EBF	2 5/8" x 10"	Stainless Steel
OSLP-210-EBF	2 5/8" x 10"	Steel

SHELF PACK: 10

Display Package Size - 4" x 12"

GAUGE: 12 (.104)

FEATURES: • (SLP) Display Packaged

• (OSLP) Polybagged

• Furnished with carriage bolts, washers & acorn cap nuts for safety and strength

• May be used on hollow metal door/frame using ANSI strike

• Works with up to 3 3/4" rose

• SLP - 3/8" offset / OSLP - 3/4" offset

FINISHES: (SLP-106, OSLP-107, OSLP-110) 630

(SLP-206, OSLP-207, OSLP-210) BP (Brass Plated),

CP (Chrome Plated), DU (Duro Coated), SL (Silver Coated),

For use with **ELECTRIC STRIKES**

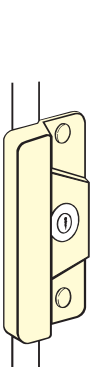

**ELP-208
ELP-208P**

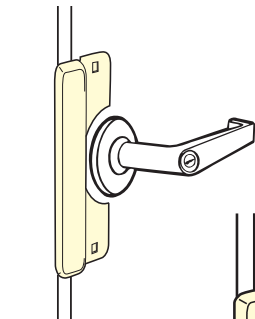

LELP-208

Fits up to
3 3/4" Rose

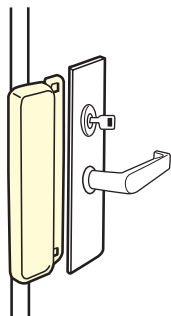

MELP 210

NUMBER	DIMENSIONS	MATERIAL
ELP-208	3 1/2" x 8"	Steel
ELP-208P	3 1/2" x 8"	
LELP-208	3 1/2" x 8"	
MELP-210	2 5/8" x 10"	
ELP-208-EBF	3 1/2" x 8"	
ELP-208P-EBF	3 1/2" x 8"	
LELP-208-EBF	3 1/2" x 8"	
MELP-210-EBF	2 5/8" x 10"	

SHELF PACK: 10

Polybagged

GAUGE: 12 (.104)

FEATURES: • Available with or without cylinder hole

• Designed to fit most electric strikes

• Completely encases the keeper for maximum protection

• Use with Mortise, Keyless Locks & Exit Devices

• ELP-208P No Cylinder Hole

FINISHES: DU (Duro Coated), SL (Silver Coated)



EBF Fasteners available with selected Latch Protectors.

Fits FOLGER ADAMS ELECTRIC STRIKE for outswinging doors

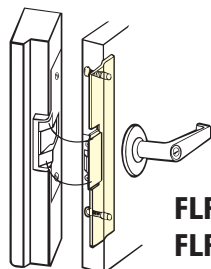

FLP-III
FLP-2II

NUMBER	DIMENSIONS	MATERIAL
FLP-111	1 3/4" x 11 1/4"	Stainless Steel
FLP-211	1 3/4" x 11 1/4"	Steel

SHELF PACK: 10 Polybagged
GAUGE: 12 (.104)
FEATURES: Works with Folger Adams 310 & 710 models
FINISHES: (FLP-111) 630
 (FLP-211) BP (Brass Plated), DU (Duro Coated)

For outswinging ALUMINUM ENTRANCE DOORS

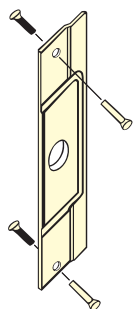

AL-211

NUMBER	DIMENSIONS	MATERIAL
AL-211	3 1/2" x 12"	Steel

SHELF PACK: 10 Polybagged
GAUGE: 12 (.104)
FINISHES: DU (Duro Coated), SL (Silver Coated)
FEATURES: Sex nuts and bolts for secure mounting and professional appearance

Fits ADAMS RITE LATCH LOCK for outswinging doors

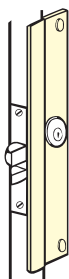

LP-312
LP-312P

NUMBER	DIMENSIONS	MATERIAL
LP-312	2 5/8" x 12"	Steel
LP-312P	2 5/8" x 12"	
LP-312-EBF	2 5/8" x 12"	
LP-312P-EBF	2 5/8" x 12"	

SHELF PACK: 10 Polybagged
GAUGE: 12 (.104)
FEATURES: • Reversible
 • 3/8" offset - 1 7/16" hole - 1 1/8" backset
 • LP-312P No Center Hole
FINISHES: DU (Duro Coated), SL (Silver Coated)

SLIMLINE for outswinging doors

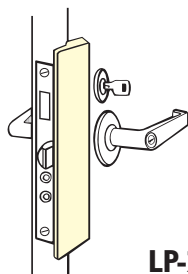

LP-2878

NUMBER	DIMENSIONS	MATERIAL
LP-2878	1 1/2" x 8 7/8"	Steel

SHELF PACK: 10 Polybagged
GAUGE: 5/16" thick (.3125)
FEATURES: Sleek appearance
FINISHES: DU (Duro Coated), PC (Prime Coated), SL (Silver Coated)