

POCKET DOOR LOCKS

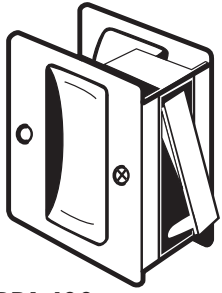

PDL-100
Passage

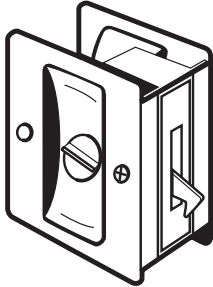

PDL-101
Privacy

NUMBER	DIMENSIONS	ANSI
PDL-100	2 1/2" x 2 3/4"	D0821
PDL-101	2 1/2" x 2 3/4"	D0831

SHELF PACK: 10

Box Pack

- FEATURES:**
- Field Reversible
 - Adjustable for various door thickness
 - Includes pin & screws for 1 3/4" door width
- FINISHES:** 605, 609, 613, 619, 620, 622, 625, 626, 605x625

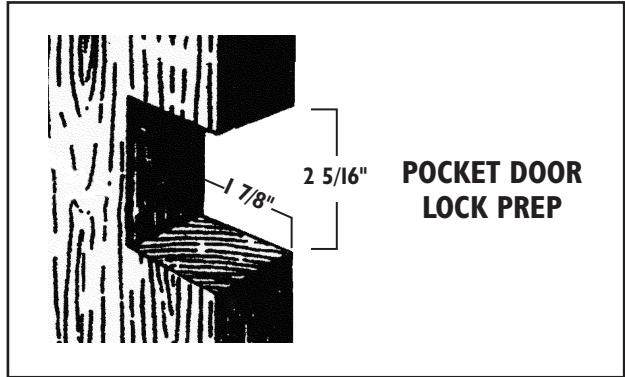

SCAR PLATES used to convert 2 3/8" to 2 3/4" backset

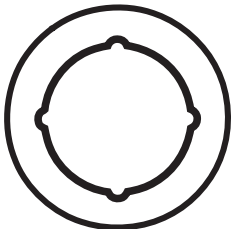

SP-135

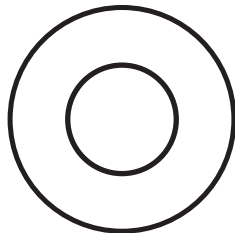

DSP-135

NUMBER	DIMENSIONS
SP-135	3 1/2" O.D - 2 1/8" I.D
DSP-135	3 1/2" O.D. - 1 1/2" I.D
PBSP-135	3 1/2" O.D - 2 1/8" I.D
PBDSP-135	3 1/2" O.D. - 1 1/2" I.D

SHELF PACK: 10

Display Package Size - 5 1/4" x 6 1/2"

- FEATURES:**
- SP-135 fits under rose of key-in-knob or deadbolt locks
 - DSP-135 fits under deadbolt collars
 - SPs & DSPs are display packed
 - PBSPs & PBDSPs are polybagged

FINISHES: 605, 609, 612, 630

SAVE \$!
Product available polybagged
To order, add prefix "PB".
(i.e., SP-135 will become PBSP-135)

REMODELER PLATES for modernizing or decorating

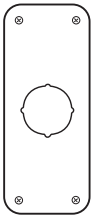

RP-13509

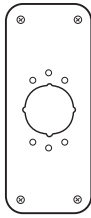

RP-13509-2

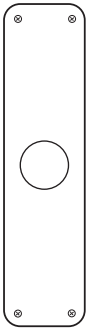

RP-13515

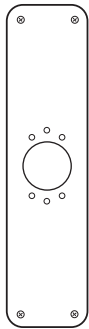

RP-13515-2



RP-E2000-14

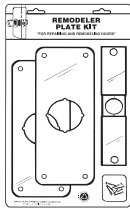

RPK-109

Kit Contains:
 (2) RP-13509
 (1) CV-86-C &
 all fasteners

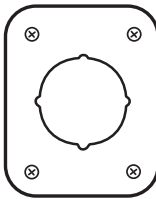

RP-13545

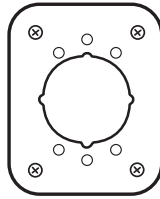

RP-13545-2

NUMBER	DIMENSIONS
RP-13509	3 1/2" x 9"
RP-13509-2	3 1/2" x 9"
RP-13515	3 1/2" x 15"
RP-13515-2	3 1/2" x 15"
RP-13545	3 1/2" x 4 1/2"
RP-13545-2	3 1/2" x 4 1/2"
RPK-109	3 1/2" x 9"
RPE2000-14	5" x 14"
RP-15	5" x 14"
RP-18	5" x 14"
RP-27	5" x 14"
RP-14-2	5" x 14"

SHELF PACK: 10 Polybagged

RPK-109 Display Packaged Size - 7 1/2" x 13"

GAUGE: .032 thick

**FINISHES: (RP-13509, RP-13509-2, RP-13545, RP-13545-2)
 605, 609, 612, 630**

**(RP-13515, RP-13515-2, RP-109, RPE2000-14,
 RP-15, RP-18, RP-27, RP-14-2) 605, 630**

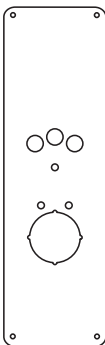

RP-18

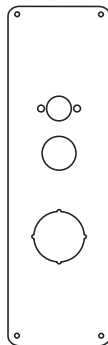

RP-15

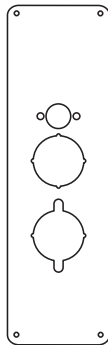

RP-27

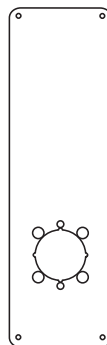

RP-14-2

DOOR VIEWERS

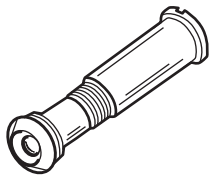

DV-90
ULDV-90
1/2" installation hole

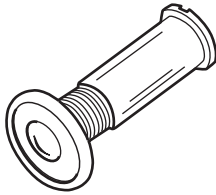

DV-180
ULDV-180
9/16" installation hole



NUMBER	VIEW DIMENS.	ANSI
DV-90	160 Degrees	L21372
DV-180	180 Degrees	L21371
ULDV-90	160 Degrees	L23222
ULDV-180	180 Degrees	L23221

SHELF PACK: 10 Polybagged
FEATURES: • For doors 1 3/8" to 2" thickness
 • DV-90 and DV-180 with plastic lens
 • ULDV-90 and ULDV-180 with glass lens are UL rated
FINISHES: 605, 626

DOOR FLIP GUARDS

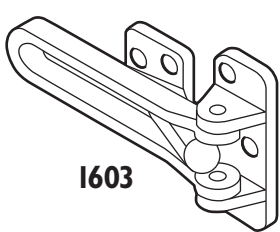

1603

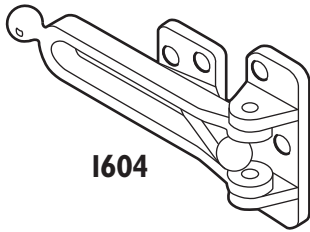

1604



AP-34
1" x 1" x 1/2"



WP-34
1" x 1"

NUMBER	ANSI	MATERIAL
1603	L33042	Aluminum
1604	L13042	Brass
AP-34	—	—
WP-34	—	—

SHELF PACK: (1603, 1604) 10 Polybagged
 (AP-34, WP-34) 100
FEATURES: • Black rubber shim available for 1603 and 1604
 • AP-34 included with item 1604
 • Both models feature Ball Bearing Design
FINISHES: (1603, 1604) 605, 606, 613, 625, 626
 (AP-34) 605, 606, 625, 626
 (WP-34) 605, 606, 625, 626, Clear

CHAIN GUARD

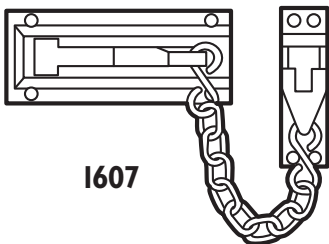

1607

NUMBER	MATERIAL
1607	Cast Brass

SHELF PACK: 20 Polybagged
FINISHES: 605, 625, 626

ELBOW CATCH

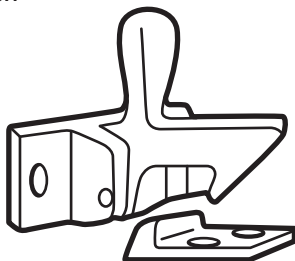

1590

NUMBER	MATERIAL
1590	Cast

SHELF PACK: 10 Polybagged
FINISHES: 605, 613, 625, 626

HANDRAIL BRACKETS

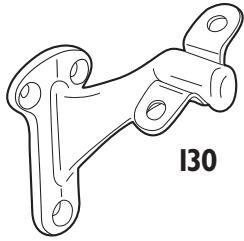

130

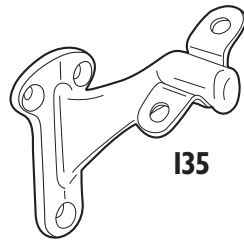

135

NUMBER	ANSI	MATERIAL
130	L33061	Cast Aluminum
135	L13061	Solid Brass

SHELF PACK: (130) 20, (135) 10

Polybagged

FEATURES: (130) Base 2 13/16" x 1 1/2"

(135) Base 2 1/4" x 1 1/4"

FINISHES: (130): 605, 609, 613, 619, 620, 625, 626

(135): 605, 613, 619, 620, 626

HINGE PINS/WINDOW BOLTS

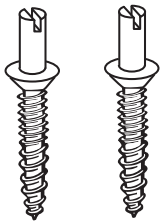

CHP-100
RHP-100

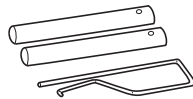

WB-112

NUMBER	DIMENSIONS
CHP-100	#12 Head
RHP-100	#10 Head
WB-112	Contains: 8 Bolts, 4 Tools

SHELF PACK: (CHP-100, RHP-100) 10 pack of 2 each

Polybagged

(WB-112) 10

FINISHES: (CHP-100, RHP-100) BP (Brass Plated), CP (Chrome Plated)

(WB-112) ZINC

COAT HOOKS

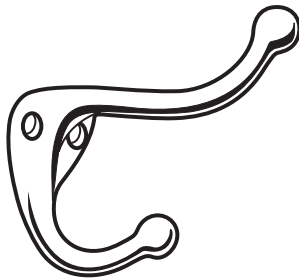

300

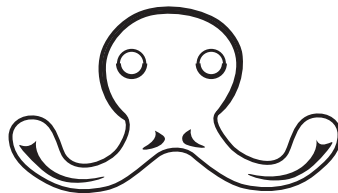

302

NUMBER	MATERIAL
300	Die Cast
302	Die Cast

SHELF PACK: 20

Polybagged

FINISHES: 605, 613, 619, 620, 625, 626

FINGER PULL

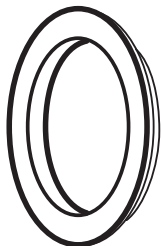

125

NUMBER	DIMENSIONS	MATERIAL
125	2 1/8"	Zinc

SHELF PACK: 50

Polybagged

FINISHES: 605, 609, 613, 619, 620, 625, 626, Black

SCAR PLATE for door damaged by prying

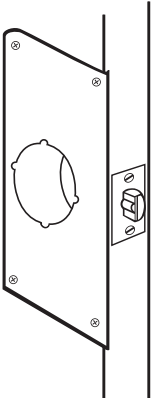

EM-2
EM-4

NUMBER	DIMENSIONS
EM-2	9" x 4" x 2 3/8"
EM-4	9" x 4 1/4" x 2 3/4"

SHELF PACK: 10

Polybagged

FEATURES: • Fits one side of door with curved lip
• Fits under key-in-knob

FINISHES: 605, 630

CRASH CHAIN

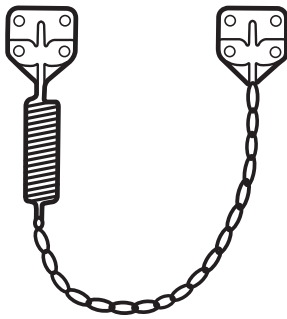

CC-100

NUMBER	LENGTH
CC-100	21 3/4"

SHELF PACK: 20

Polybagged

FEATURE: Vinyl Cover

FINISHES: Zinc

EDGE PULLS

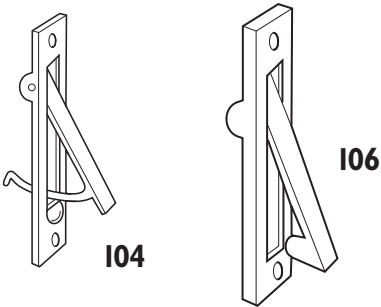

104

106

NUMBER	DIMENSIONS
104	3 7/8" x 3/4"
106	6" x 1 1/4"

SHELF PACK: 10

Polybagged

FINISHES: 605, 613, 619, 620, 626

WINDOW LOCK

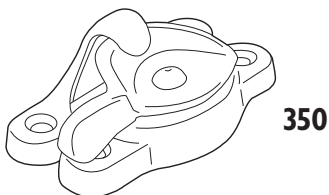

350

NUMBER	DIMENSIONS		MATERIAL
	BASE	STRIKE	
350	15/16" x 2 5/8"	5/8" x 2 5/8"	Steel

SHELF PACK: 10

Polybagged

FINISHES: 605, 613, 619, 626

NUMBERS/DOOR KNOCKERS

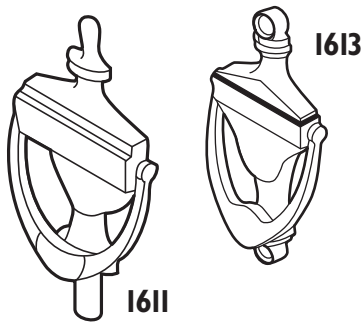

378

**BN4 (shown)
- BN6**

**How to Order:
eg: BN4-2-605**

NUMBER	DIMENSIONS	ANSI
1611	6 7/8" x 3 1/2"	L13151
1613	3 7/8" x 2 1/4"	L13151
BN4	4"	-
BN6	6"	-

SHELF PACK: 10 Polybagged
FEATURE: Forged Brass
FINISHES: 605

CYLINDER GUARDS

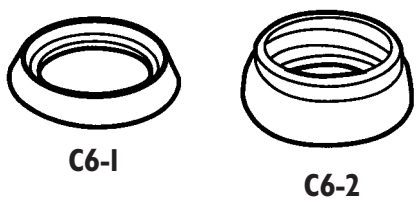

NUMBER	DIAMETER	THICKNESS	MATERIAL
C6-1	1 1/8"	1/4"	Steel
C6-2	1 1/8"	3/8"	Steel

SHELF PACK: 10 Polybagged
FINISHES: BP, CP, DU

CYLINDER RINGS

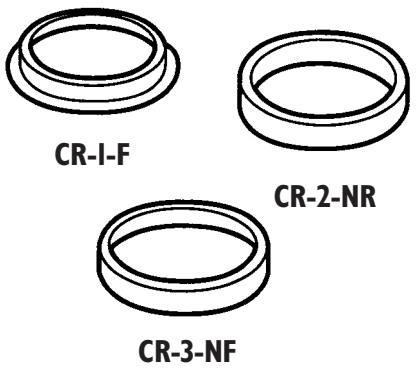

NUMBER	DIAMETER	THICKNESS	MATERIAL
CR-1-F	1 1/4"	1/4"	Aluminum
CR-2-NR	1 1/8"	1/4"	Aluminum
CR-3-NF	1 1/8"	1/4"	Brass

SHELF PACK: 10 Polybagged
FINISHES: BP, CP, DU

CYLINDER RINGS

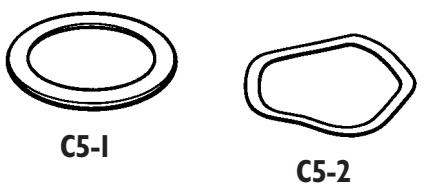

NUMBER	DIAMETER	THICKNESS	MATERIAL
C5-1	1 1/8"	1/16"	Plastic
C5-2	1 1/8"	3/16"	Brass

SHELF PACK: 10 Polybagged
FINISHES: Clear plastic, 605